

FURNITURE AND AUXILIARIES

FURNITURE

Depth 48,5

Depth 51

Depth 48,5

Depth 51

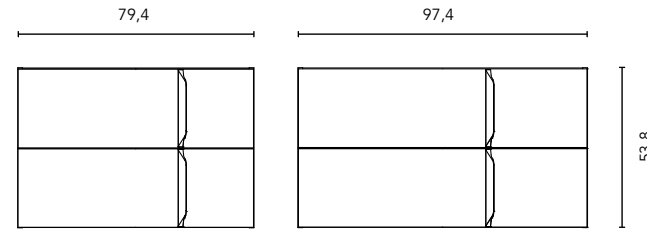
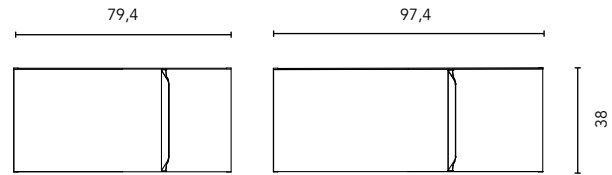

For single-drawer cabinets, 1 organiser box is included,
for two-drawer cabinets, 2 organiser boxes are included.

COLUMN

Depth 24

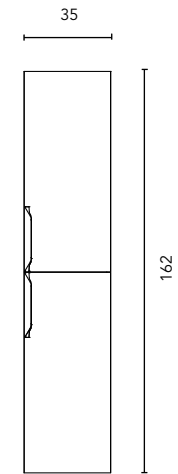

WALL

Depth 15

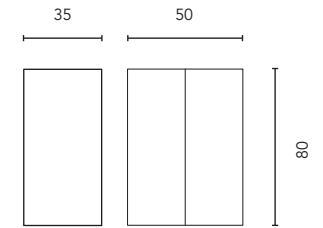

FINISHES



NATURE WHITE



NATURE BEIGE



MATT SAND

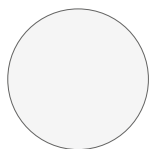

MATT WHITE

Tube depth 7 cm.

1 Drawer

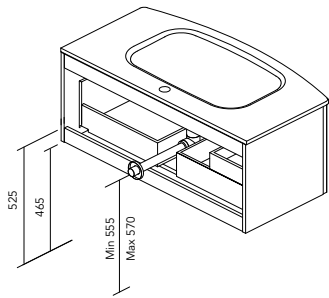

2 Drawers

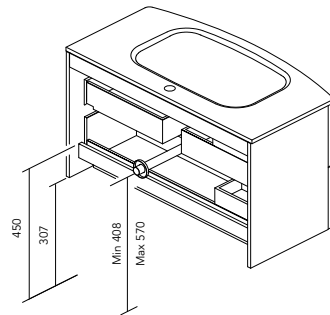

SIDE PANELS	FRONTS	DRAWERS				FINISHES	HANDLE	RANGE	
Fiberboard 16 mm	MDF. 18 mm	Partially extraction Hettich	Smoky leather interior	Drawer organiser	Soft close	Foil 3D	Patented covered handle	Curved	Suspended

* Dimensions indicated in the drawing are based on the level of the whole leg, in case of wall hanging the furniture dimensions. The measures of these schemes are represented in mm.